





SKU: BV5058

-  VOLT Mini Ball Valve F x F, Screwdriver Operator
-  VOLT Mini -Kugelhahn F x F , Schraubenzieher Operator
-  Válvula de bola mini VOLT F x F , Operador Destornillador
-  VOLT VOLT Mini Ball Valve F x F , tournevis opérateur

Valves[™]
O N L I N E

- 1/8 " – 3/4" Mini brass polished chrome plated ball valve
- 1/8 " - 3/4" Mini Messing poliert verchromt Kugelhahn
- 1/8 " - 3/4" Mini latón pulido cromado válvula de bola
- 1/8 " – 3/4" Mini laiton chromé de vanne à boisseau sphérique poli

**Brass Ball Valve
Screwdriver Operated
F x f BSPP**



- Chrome Plated
- Screwdriver Slot Operation
- Screwed BSPP
- -10°C to 90°C
- PN16 Rated

DESCRIPTION

Chrome plated F x F, mini ball valve with Screwdriver operator, for use on pneumatic and liquid applications. Valve offers reliable on / off operation. Holds water research council approval WRAS.



Description

Polished chrome plated mini ball valve with winged operator, reduced bore screwed BSPP female x female. 1/8" – 3/4" PN16, Temperature Range -10° C to 90° C. Typically used in pneumatic systems, HVAC and small industrial isolation use.



Beschreibung

Poliert verchromt Mini -Kugelhahn mit Flügelbetreiber, reduzierter Durchgang geschraubt BSPP weiblichen x weiblich. 1/8 "- 3/4" PN16, Temperaturbereich -10 ° C bis 90 ° C
Typischerweise in Druckluftanlagen , Klimatechnik und kleine IndustrieisolationGebrauch verwendet .



Description





Cromo pulido plateado de mini válvula de bola con el operador alado , paso reducido atornillado BSPP hembra x hembra . 1/8 " - 3/4" PN16 , Rango de temperatura de -10 ° C a 90 ° C.
Normalmente se utiliza en sistemas neumáticos , HVAC y los pequeños el uso de aislamiento industrial.



Descripción

Chromé poli mini- vanne à boisseau sphérique avec opérateur ailé, passage réduit vissé BSPP femelle x femelle. 1/8 " - 3/4" PN16 , plage de température -10 ° C à 90 ° C.
Généralement utilisé dans les systèmes pneumatiques , CVC et petite utilisation d'isolation industrielle .

WRAS
APPROVED
PRODUCT

-  VOLT Mini Ball Valve F x F, Screwdriver Operator
-  VOLT Mini -Kugelhahn F x F , Schraubenzieher Operator
-  Válvula de bola mini VOLT F x F , Operador Destornillador
-  VOLT VOLT Mini Ball Valve F x F , tournevis opérateur

2/2 Mini brass ball valve

An aesthetically pleasing hard chrome plated, polished mini ball valve. Reduced bore screwed female x female BSP. screwdriver slot with 90° turn.

Typical Applications: Isolation on Pneumatic system in small areas where a lever valve will not fit.

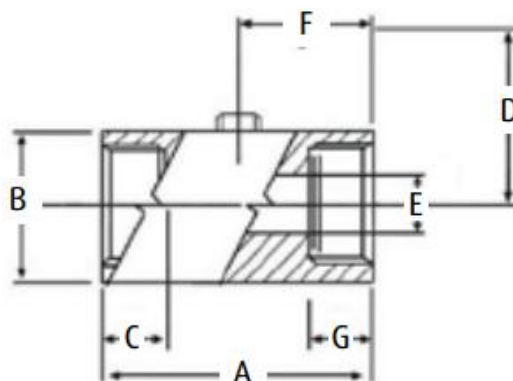

Dimensions shown are for guidance only

Dimensions								
DN	G	C	A	E	B	D	F	Kg
1/8"	9	9	39	6	21	12.5	18	0.08
1/4"	9	9	39	8	21	12.5	18	0.09
3/8"	10	9	42	8	21	12.5	21	0.07
1/2"	10.5	10.5	47	10	25	14.5	24	0.1
3/4"	13.5	13.5	54	12	30	17	27	0.19

Material List	
Body	Brass, Nickel plated
Sleeve	Brass
Ball	Brass nickel plated
Seat	PTFE
Stem O-ring	NBR
Handle	Glass Fibre Reinforced Nylon

Pressure / Temperature Ratings	
Working Pressure	PN16
Temperature	-10°C to 90°C

