





SKU: SV5226

-  VOLT Servo Assisted 2 Way High Pressure Solenoid Valve
-  VOLT Servolenkung 2-Wege- Hochdruck -Magnetventil
-  VOLT Servo asistida de 2 vías de alta presión de la válvula de solenoide
-  VOLT Servo assistée 2 voies haute pression électrovanne

Valves[™]
O N L I N E

- 3/8" - 1" Normally Closed 2 Way Brass Solenoid 0.5-50 Bar
- 3/8" - 1" Normalerweise Messing Magnet Geschlossen 2-Wege- 0,5-50 Bar
- 3/8" - 1" Latón normalmente cerrado solenoide de 2 vías 0,5-50 Bar
- 3/8" - 1" Normalement fermé 2 voies en laiton Solenoid 0,5-50 bar



- **Media: Air, water, light oil,**
- Pressure range: 0.5 to 50 bar max
- Media temperature: Up To 90° C max
- Ambient temperature: -10° to +50° C max
- Media viscosity: 50 centistokes max
- Mounting: Any Position
- Opening Closing time: 500 m Sec max
- Body: Brass
- Seal & Gaskets: PTFE + NBR

Servo-Assisted High Pressure Solenoid Valve 0.5 - 50 Bar

Normally Closed



Description

Servo-Assisted brass solenoid valve, suitable for high pressures from 0.5 up to 50 Bar. This valve needs a differential pressure of 0.5 Bar to operate correctly. Typical applications are pumped systems on neutral air, gasses such as compressed air, natural gas, and water. 3/8" - 1" BSPP connections with PTFE + NBR seal materials.



Beschreibung

Servo - Assisted Messing -Magnetventil , geeignet für hohe Drücke von 0,5 bis 50 bar . Dieses Ventil braucht ein Differenzdruck von 0,5 bar korrekt arbeiten . Typische Anwendungen sind gepumpten Systemen auf neutralem Luft , Gase wie Druckluft , Erdgas und Wasser. 3/8 " - 1" BSPP Verbindungen mit PTFE + NBR Dichtungsmaterialien .



Descripción





la válvula de solenoide de latón servo - asistida , adecuado para altas presiones desde 0,5 hasta 50 bar . Esta válvula necesita una presión diferencial de 0,5 bar para funcionar correctamente. Las aplicaciones típicas son sistemas bombeados en el aire neutral, gases tales como aire comprimido , gas natural, y agua. Conexiones BSPP con materiales de la junta de PTFE + NBR - 3/8 " 1 " .



Description

laiton électrovanne Servo - assistée , adapté pour les hautes pressions de 0,5 à 50 bar . Cette vanne a besoin d'une pression différentielle de 0,5 bar pour fonctionner correctement. Les applications typiques sont les systèmes pompés sur l'air neutre, les gaz tels que l'air comprimé , le gaz naturel , et de l'eau . connexions BSPP avec des matériaux d'étanchéité PTFE + NBR - 3/8 "1" .



-  VOLT Servo Assisted 2 Way High Pressure Solenoid Valve
-  VOLT Servolenkung 2-Wege- Hochdruck -Magnetventil
-  VOLT Servo asistida de 2 vías de alta presión de la válvula de solenoide
-  VOLT Servo assistée 2 voies haute pression électrovanne

Servo-Assisted Brass High Pressure Solenoid Valve

- Servo Assisted
- 0.5-50 Bar
- Normally Closed
- Good for Air and Liquids
- Supplied with plug
- Various Voltages
- PTFE + NBR Seals

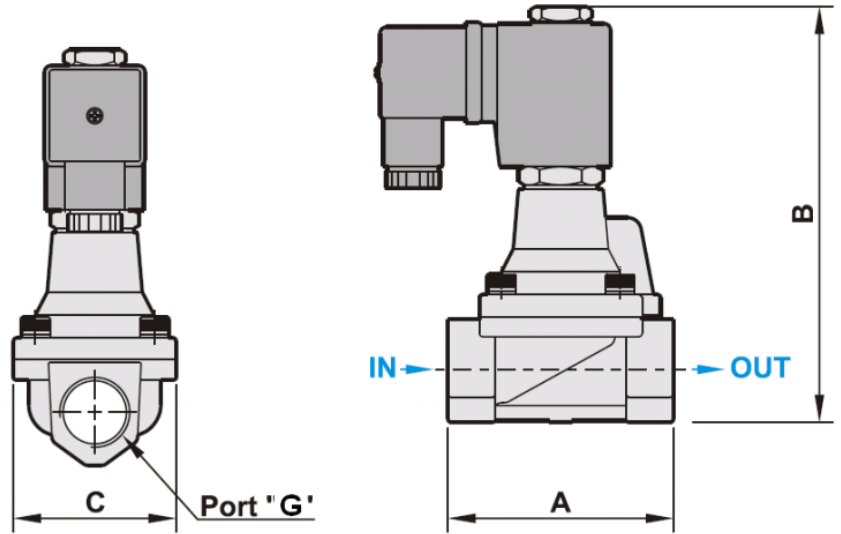

Electrical Data					
Voltage (-10% + 10%) Continuous duty 100%	Coil	Power Consumption		Insulation Class	IP Rating With Connector
		Inrush	Hold		
24 – 110 – 220 - 380 (50 or 60 Hz)	22003	23VA	17 VA	H 180°C	3 Pins Din43650, Din 40050, VDE 0110
12 – 24 - 48 (DC)		15 Watts			

Seal Material	
90° C	PTFE + NBR

IP65 Coil & IP65 Connector PG9 – DIN 43650 A
 ATEX 22003EX Coil: ATEX EExmIT4 II 2G & 2D IP65 T130°C (Pressure rating reduce by 30%)
 NPT Thread
 Other custom made options available upon request

Construction	
Body	Die Cast Brass
Tube & Internal Parts	Stainless Steel
Head & Plunger	Stainless Steel
Seals and gaskets	PTFE + NBR
Moulded Coil	Resin

SPECIFICATIONS							Dimensions		
Port	Orifice	Kv Ltr/min	Pressure Rating (Bar)			Weight Kg	A	B	C
			Min	Max AC	Max DC				
3/8"	13	40	0.5	50	50	0.86	66.5	106	48
1/2"	13	40				0.84	66.5	107	48
3/4"	25	95				1.8	100	127	70
1"	25	165				1.75	100	127	70

