





SKU: BS5034

-  Cast Iron Basket Strainer
-  Korb-Schmutzfänger aus Gusseisen
-  Tamiz de la cesta de hierro fundido
-  Crapaudine en fonte

Valves[™]
O N L I N E

- 1" - 8" Cast Iron Simplex Basket Strainer PN16
- 1" - 8" Gusseisen Simplex Korb Schmutzfänger PN16
- 1" - 8" Hierro fundido simple cesta colador PN16
- 1" - 8" Fonte Simplex panier passoire PN16



- 13.8 Bar
- Temp 120°C
- PN16 Flanged ends
- Full bore
- Various Mesh size available

Description

The VOLT Cast Iron Simplex Basket Strainer provides a simple solution to separate particles and impurities in a process fluid flow system where temporary interruption is permitted for basket cleaning. Where continuous uninterrupted flow is required we would offer our range of Duplex Strainers. Up to 13.8 Bar max. working pressure Temp -20°C to 120°C

Cast Iron Flanged PN16 Simplex Strainer



Description

Cast Iron Body and cover, simplex basket strainer, flanged PN16. The basket is in stainless steel with the choice of various mesh sized perforations. Up to 13.8 Bar max. working pressure Temp -20°C to 120°C



Beschreibung

Grauguss-Körper und Deckel, simplex Korb Schmutzfänger, Flansch PN16. Der Korb ist aus rostfreiem Stahl mit der Wahl der verschiedenen Maschen Größe Perforationen. Bis zu 13,8 Bar Max. Arbeitsdruck Temp - 20 bis 120 ° c



Descripción

Cuerpo de hierro fundido y tapa, colador de canasta simplex, brida PN16. La cesta es de acero inoxidable con la opción de varias perforaciones de tamaño de malla. Hasta 13,8 Bar máx. presión de trabajo Temp - 20 ° c a 120 ° c



Description

Corps en fonte et couverture, crapaudine simplex, à brides PN16. Le panier est en acier inoxydable avec le choix de perforations de maillage de taille différentes. Jusqu'à 13,8 max Bar. pression de travail Temp - 20 ° c à 120 ° c

Fully Maintainable
Various Options



Cast Iron Basket Strainer
 Korb-Schmutzfänger aus Gusseisen
 Tamiz de la cesta de hierro fundido
 Crapaudine en fonte



Cast Iron Simplex Basket Strainer

- 13.8 Bar
- Temp 120°C
- PN16 Flanged ends
- Full bore
- Various Mesh size available

Choice of Strainer Type:

If the flow can be interrupted to enable cleaning of the basket use a **Simplex Basket Strainer**
 If the flow needs to be continuous even when the basket needs cleaning use a **Duplex Basket Strainer**

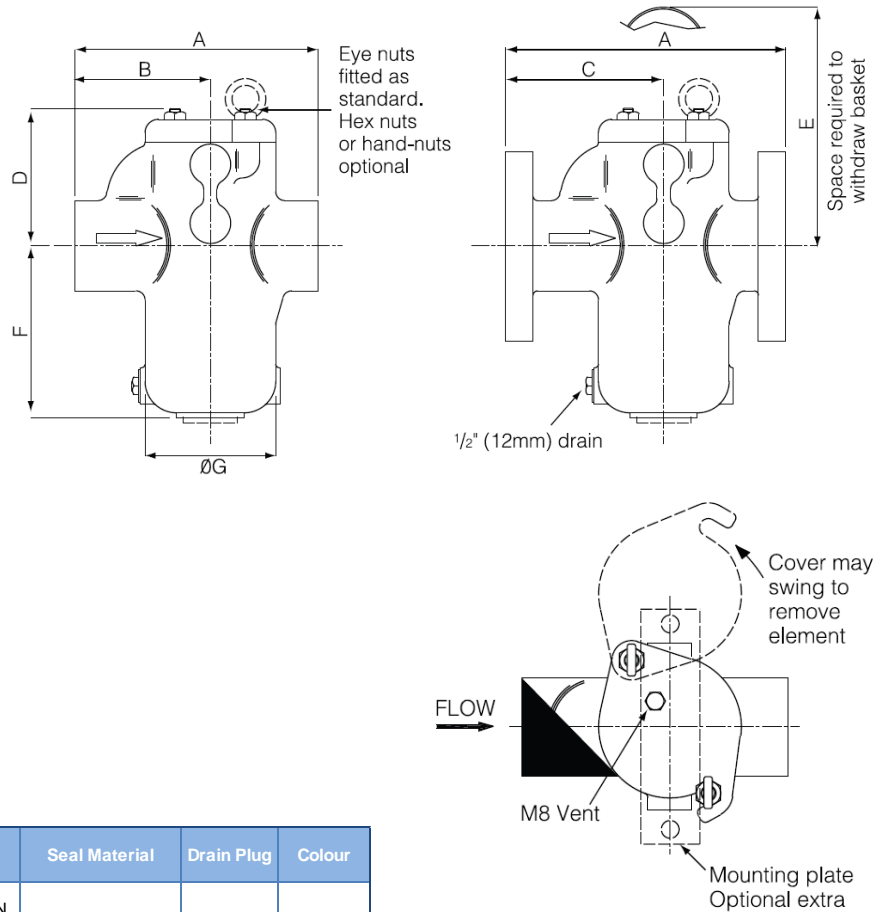

Type	Body and Cover Material	Seal Material	Drain Plug	Colour
XS	Cast Iron BS EN1561 EN-JL1030 DIN 1691 GG25 ASTM A48/76 Class 35	Nitrile Max. 120°C	Bronze	Blue

Dimensions 1" to 8"								Basket Area	Mass (Dry)
Size	A	B	C	E	D	F	G		
1"	195	90	110	245	95	126	100	200	14
1 1/2"	210	95	115	310	120	160	100	280	14
2"	310	150	170	355	155	160	145	514	26
2 1/2"	310		170	355	155	160	145	514	30
3"	345		200	455	195	210	160	770	38
4"	355		210	580	225	270	160	1018	48
6"	415		255	680	270	280	170x345	2036	81
8"	485		242.5	565	223	385		4076	170



Cast Iron Basket Strainer
 Korb-Schmutzfänger aus Gusseisen
 Tamiz de la cesta de hierro fundido
 Crapaudine en fonte

Cast Iron Simplex Basket Strainer

no	Name of Parts	No. Off
1	Body	1
2	Filter Cover	1
3	Basket Assembly	1
4	Drain Plug	1
5	Bleed Screw	1
6	O Ring Cover	1
7	O Ring Basket	1
8	O Ring Drain	1
9	O Ring Bleed	1
10	Stud	3/4.
11	Eye Nut	2

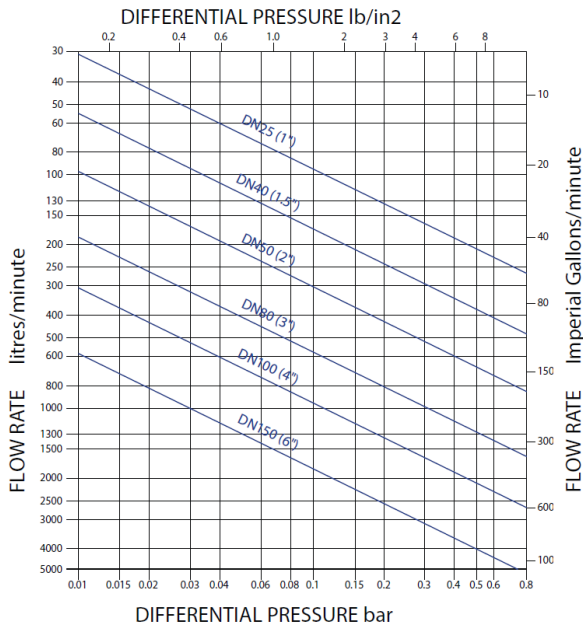
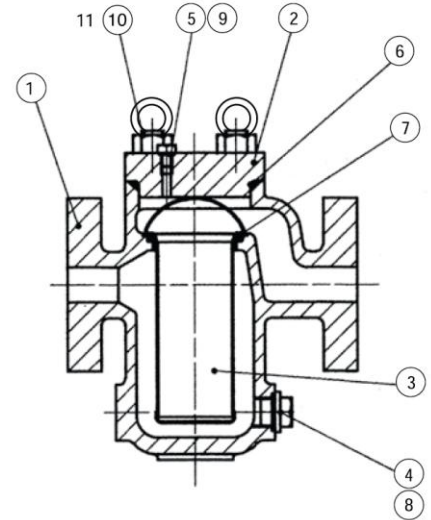

Viscosity (Centistokes)	Filtration Rating (mesh Size)					
	Perf.	20	40	80	120	200
1	1	1	1	1.1	1.2	1.3
50	1.6	1.7	1.9	2.1	2.3	2.5
100	1.7	1.9	2.1	2.4	2.6	2.9
200	2	2.2	2.5	2.9	3.2	3.6
400	2.2	2.7	3.1	3.5	3.9	4.4
800	2.9	3.4	3.8	4.1	4.9	5.8
1500	5	5.8	6.4	6.9	8.1	10.2

The chart is for water (1cSt) flowing through a filter with an element coarser than 1 millimeter perforations. Multiply the chart pressure drop by the following factors for different ratings and different viscosities to calculate the actual pressure drop.

Perforated baskets in stainless steel 316 and available with 1mm, 2mm or 3mm or larger diameter holes.

Mesh Size	Size of Aperture
20	0.91mm
30	0.56mm
40	0.38mm
60	0.25mm
80	0.19mm
120	0.13mm
200	0.08mm
300	0.05mm

Factors to be Taken Account of when Selecting a Strainer:

- Fluid type (refer to our compatibility tables)
 - Flow
 - Viscosity
 - Temperature – operating and design
 - Pressure – operating and design
 - Degree of filtration required
 - Connection Type
- PN16, ASA150, screwed BSP, NPT
- Any special requirements i.e. heating jacket, magnets, mounting brackets, dp indicator/switch etc.